

FIDEL

Typ C

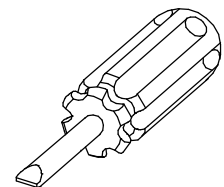

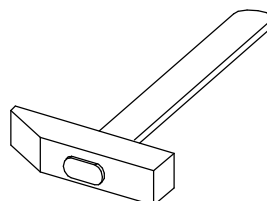

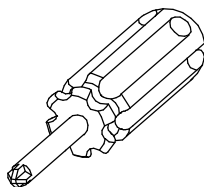
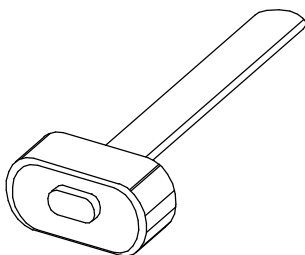
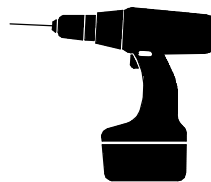
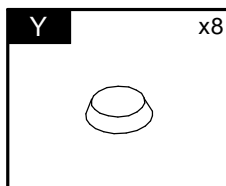
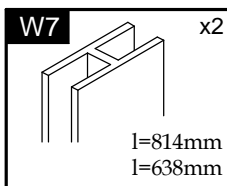
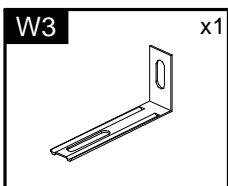
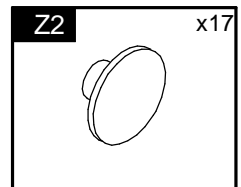
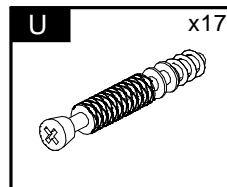
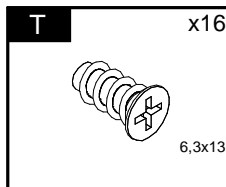
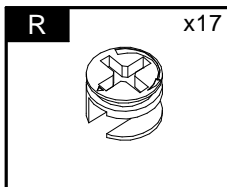
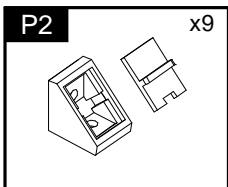
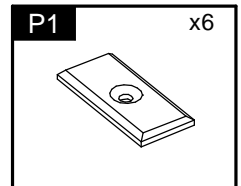
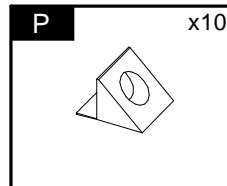
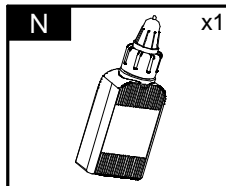
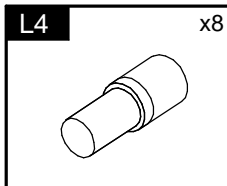
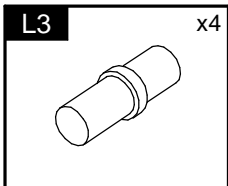
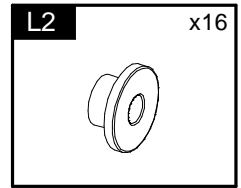
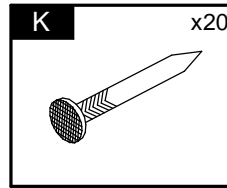
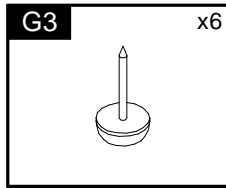
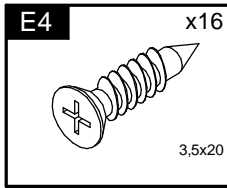
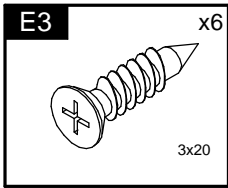
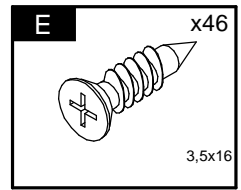
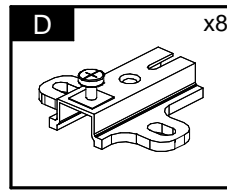
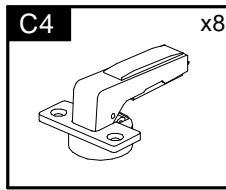
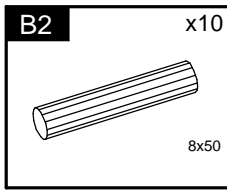
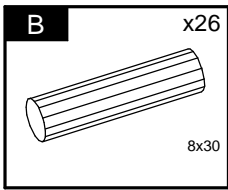
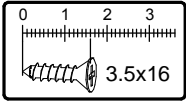
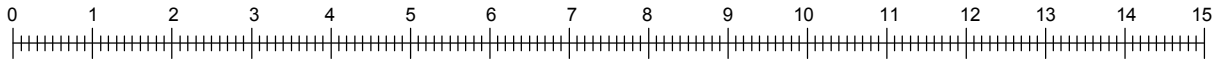

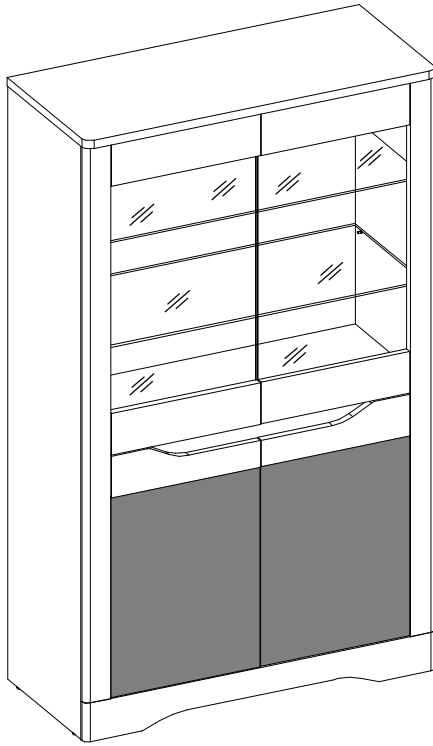

Element symbol	Measurements				Code	Paket
1	949	422	22	1	1002/2002	1/2
2	400	84	22	1	1008	1/2
3	1568	396	16	1	1028	1/2
4	1568	396	16	1	1004	1/2
5	913	382	16	1	1005	1/2
6	913	382	16	1	N/A	1/2
7	913	70	16	1	1025	1/2
8	913	364	16	1	1026	1/2
9	529	400	16	1	1018	1/2
10	529	400	16	1	1020	1/2
11	829	463	3	1	1031_v	1/2
12	829	463	3	1	N/A	1/2
13	661	463	3	2	N/A	1/2
14	402	112	19	1	1001/3001	1/2
15	402	112	19	1	1006/3002	1/2
16	402	112	19	1	1001/3003	1/2
17	402	112	19	1	1007/3004	1/2
18	401	111	19	1	1002_v	1/2
19	401	111	19	1	1011_v	1/2
20	948	103	19	1	1012/3007	1/2
21	1468	72	19	1	1015/3008	1/2
22	1468	72	19	1	1015/3009	1/2
23	659	398	4	2	Glass	2/2
24	912	374	6	2	Glass	2/2

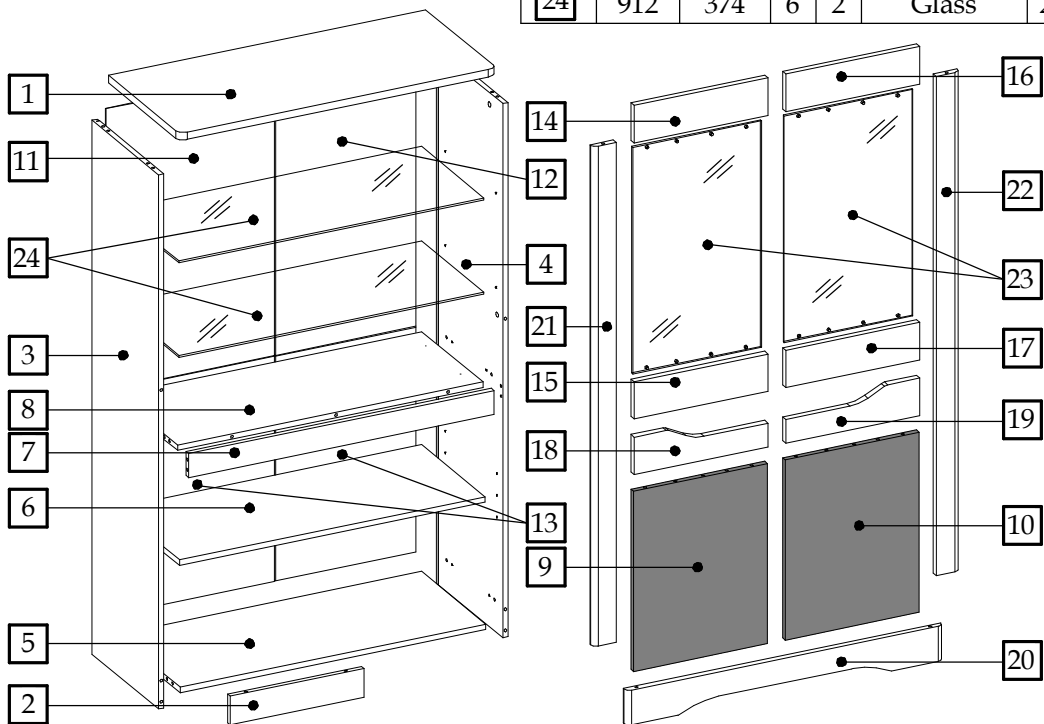

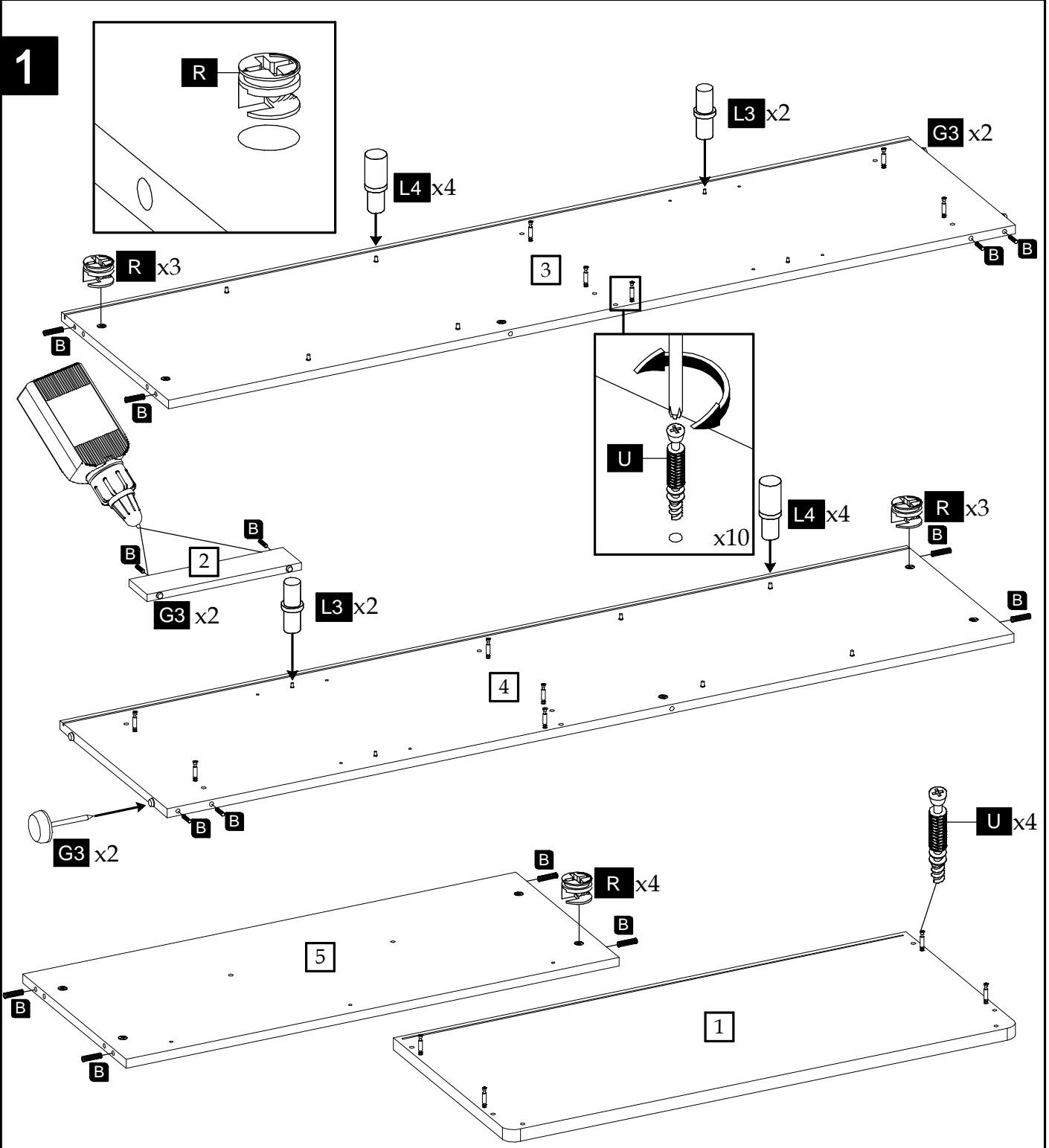

2

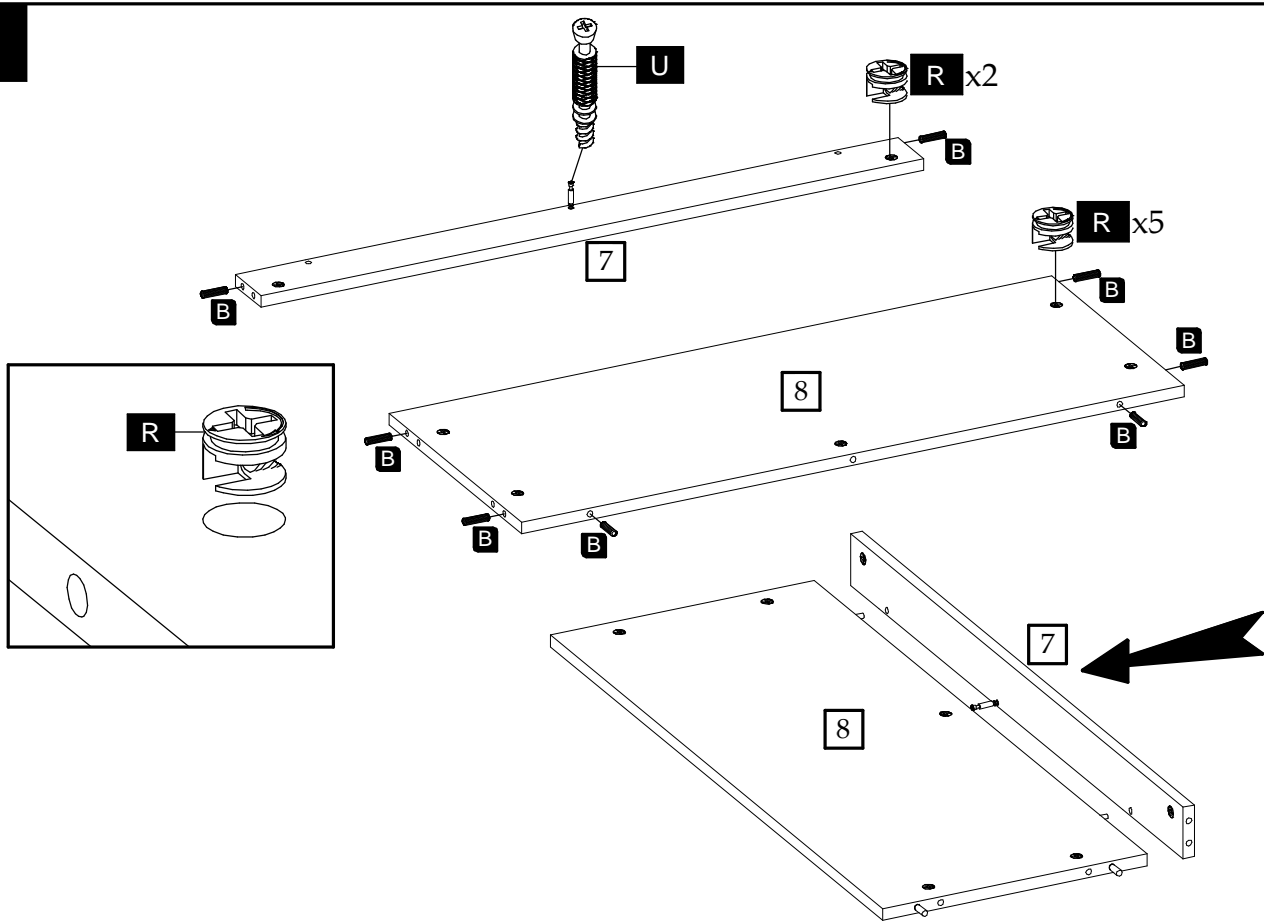

3

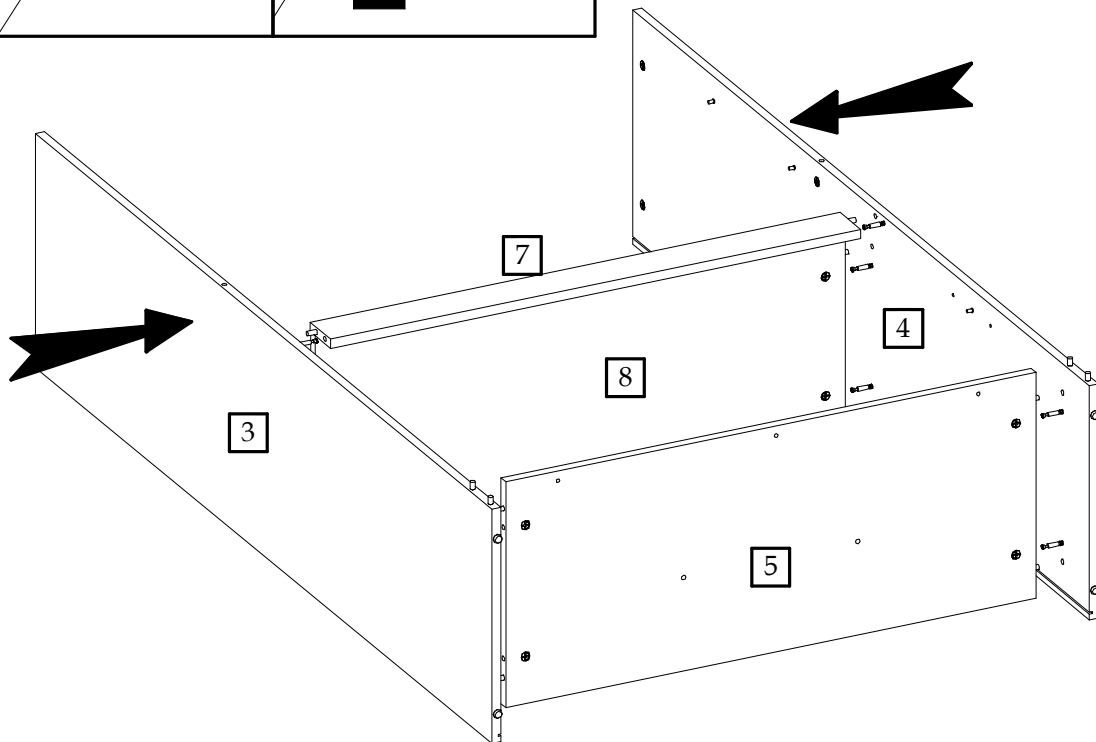
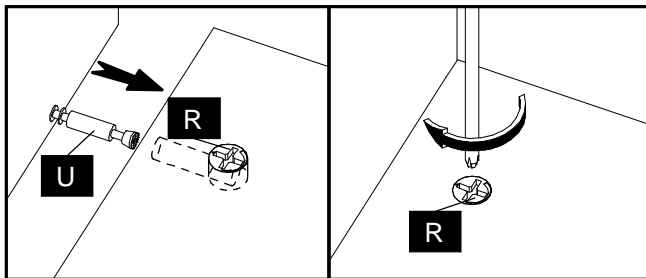

4

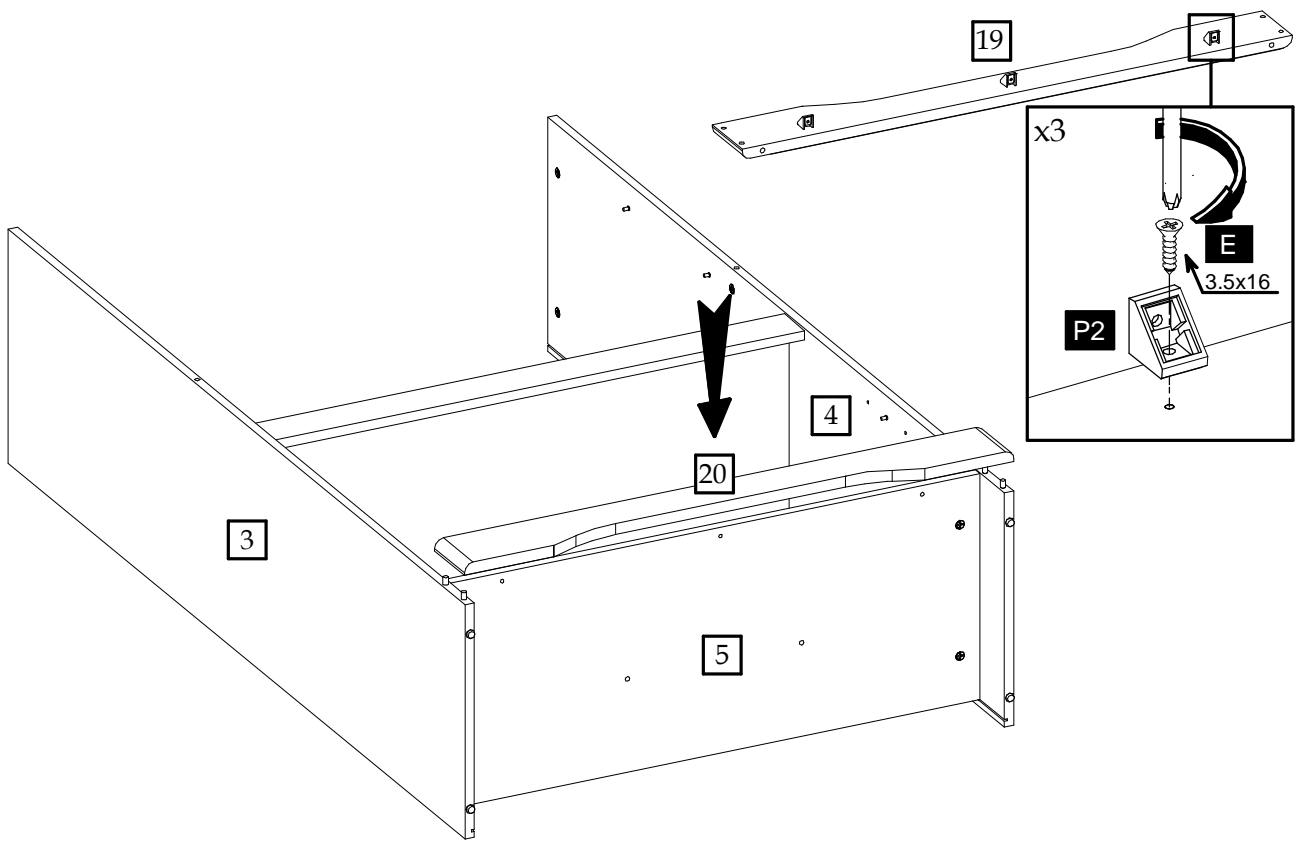

5

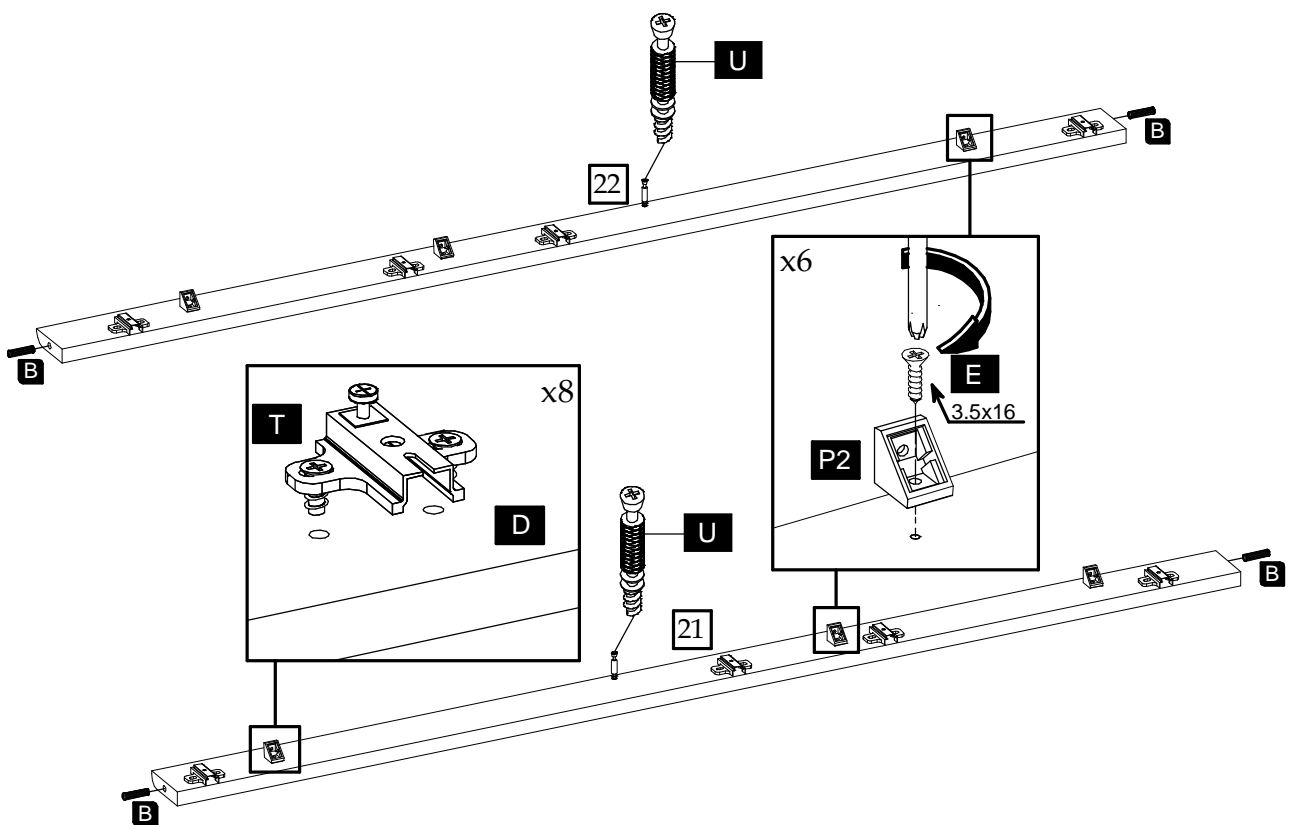

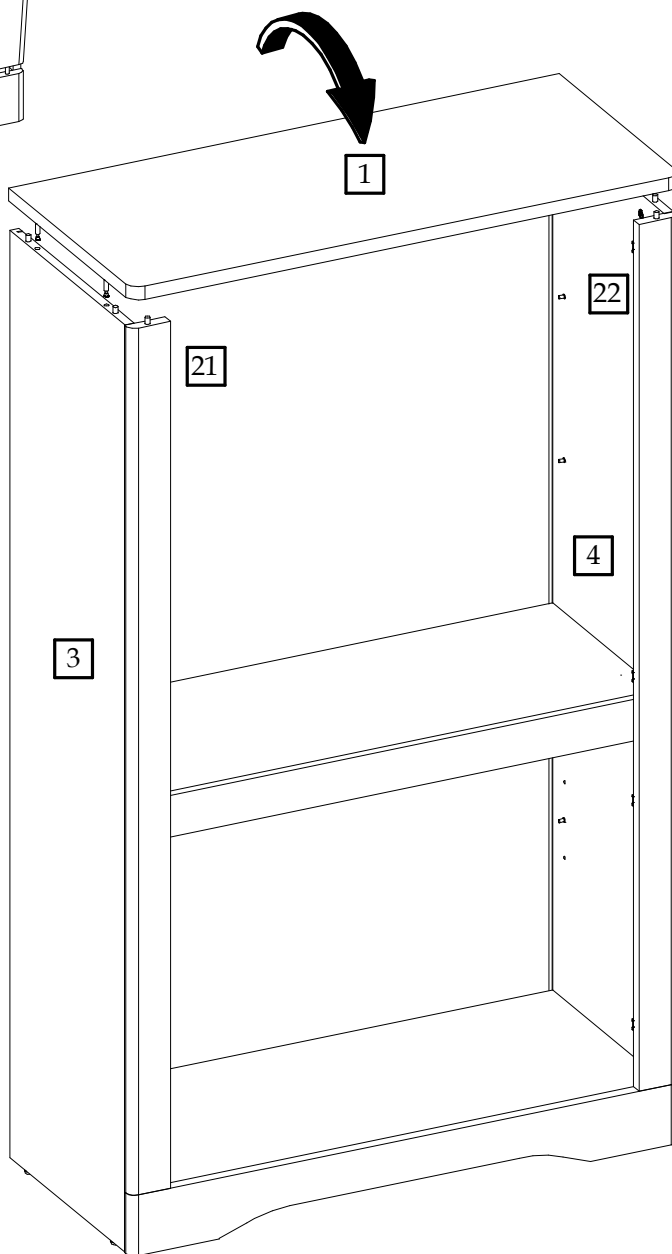
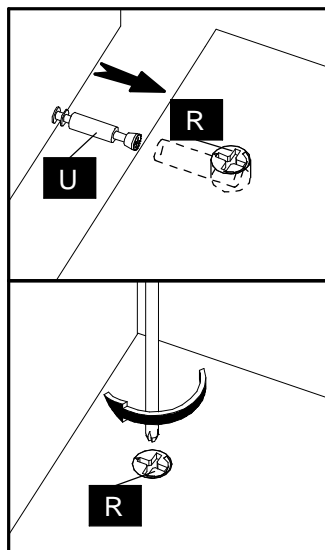
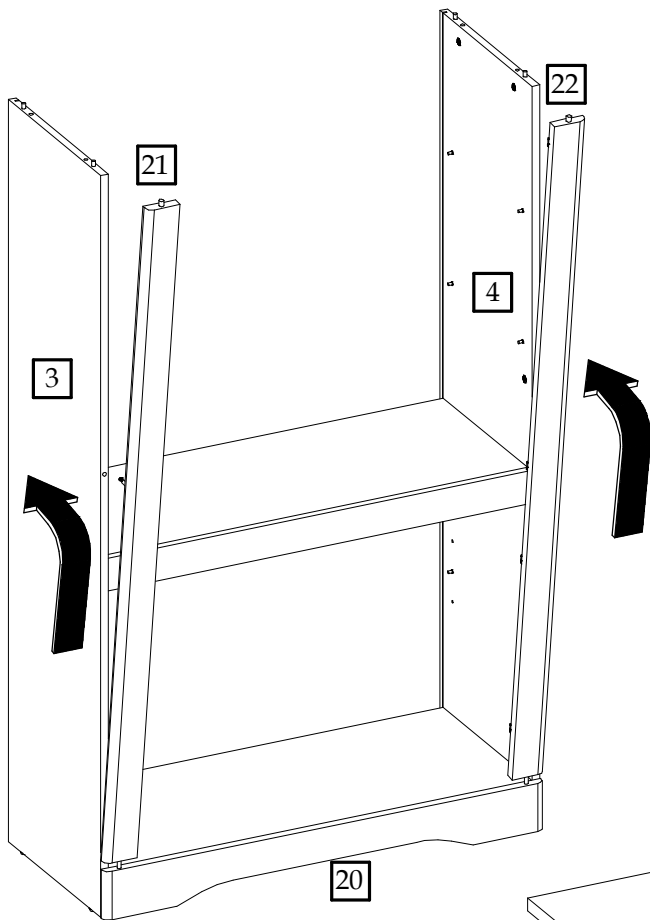

7

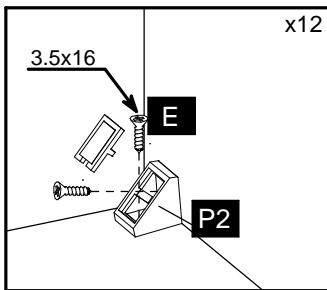
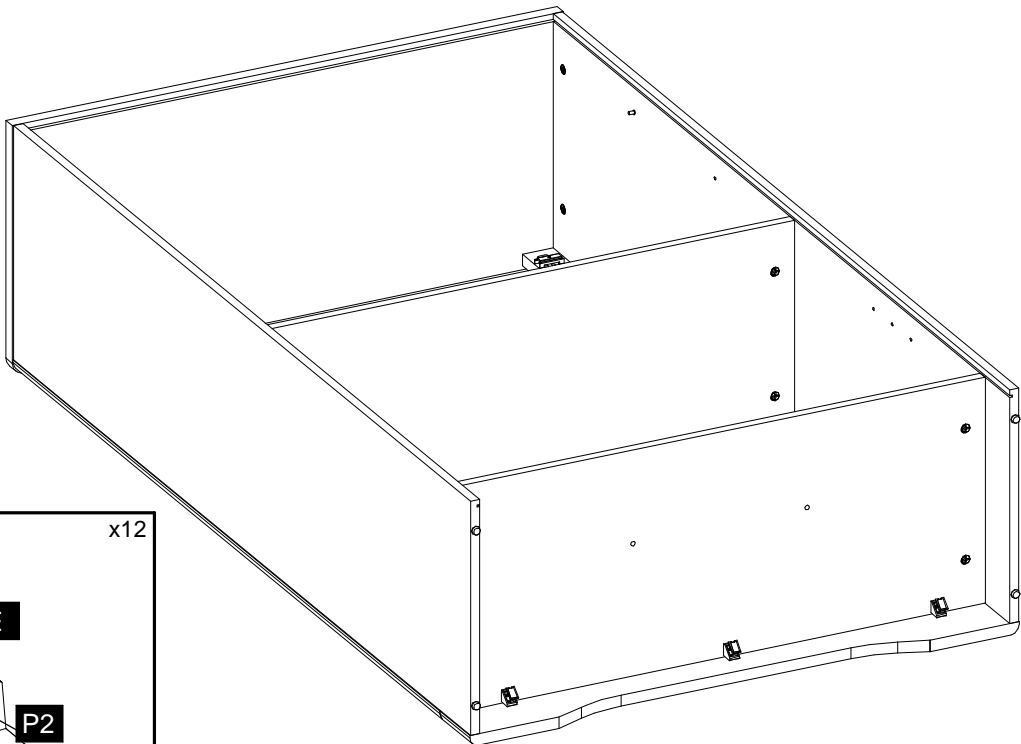

8

